



TITLE: Vieo Vertical Wall Covering (On Ply or OSB)

DWG NO: V10_VWC_TD_System

SCALE: NTS

ISSUE DATE: Feb 2019

Drawn by: CD Checked by: MP

(To be read in conjunction with Vieo system specification documents)

**Euroclad Group Ltd,
Wentloog Corporate Park,
Wentloog Road, Cardiff CF3 2ER
Tel: +44 (0)2922 010101
Fax: +44 (0)2922 010122
Website: www.vieorooft.com**

This draft drawing has been supplied by Euro Clad Ltd for the purpose of guidance free of charge. It is a suggested typical detail and as such should not be assumed suitable for any specific project or application. No responsibility is assumed for errors or misinterpretations resulting from the information contained in the drawing. Details are for illustration only and no liability is accepted. We reserve the right to change the details without notice. The drawing is copyright, it remains our property.

Standard offer is 454mm profile.
Also available on request in other widths from 200mm to 517mm.
Above 454mm is not Technically supported.

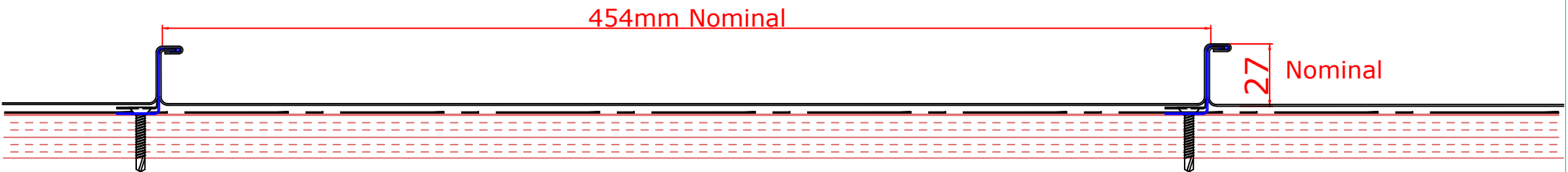

Ply/Timber/OSB facing by others in accordance with relevant standards.



TITLE: Vio Vertical Wall Covering (On Ply or OSB)

DWG NO: V10_VWC_TD_System

SCALE: NTS

ISSUE DATE: Feb 2019

Drawn by: CD Checked by: MP

(To be read in conjunction with Vio system specification documents)

**Euroclad Group Ltd,
Wentloog Corporate Park,
Wentloog Road, Cardiff CF3 2ER
Tel: +44 (0)2922 010101
Fax: +44 (0)2922 010122
Website: www.vioeroof.com**

This draft drawing has been supplied by Euro Clad Ltd for the purpose of guidance free of charge. It is a suggested typical detail and as such should not be assumed suitable for any specific project or application. No responsibility is assumed for errors or misinterpretations resulting from the information contained in the drawing. Details are for illustration only and no liability is accepted. We reserve the right to change the details without notice. The drawing is copyright, it remains our property.

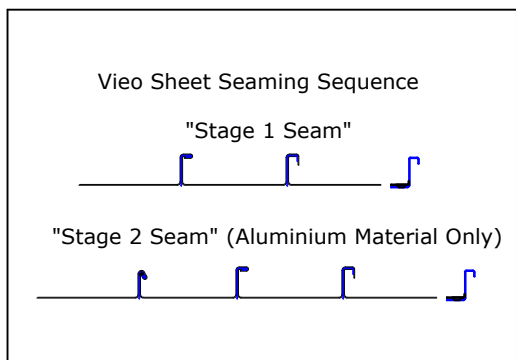
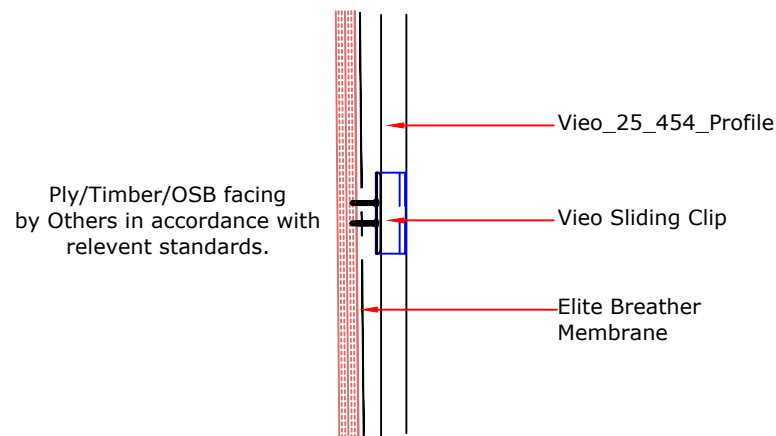
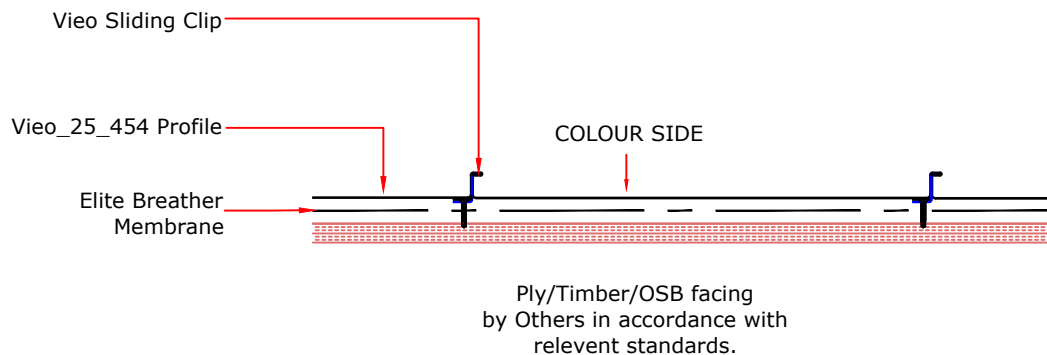

TYPICAL ARRANGEMENT: 1260mm IN CENTRAL AREAS, REDUCE CLIP CENTRES AT CORNERS AND IN HIGH LOAD AREAS.

CHECK SYSTEM CAPACITY AGAINST PROJECT LOADS AND ADJUST IF NECESSARY

CLIP TYPICAL CENTRES (APPLICABLE FOR STAGE 1 ALUMINIUM VIO SHEETS ONLY):

DETERMINED BY PROJECT WIND SUCTION LOADS AS FOLLOWS:

1260mm for loads up to 0.8kN/M²

660mm for loads 0.8 to 1.2kN/M²

300mm for loads 1.2 to 3kN/M²

Where substrate is Min 18mm ply or Min 15mm OSB 3

IF HIGHER WIND LOADS ARE ANTICIPATED PLEASE REFER TO BELOW;

CLIP TYPICAL CENTRES (APPLICABLE FOR STAGE 2 ALUMINIUM VIO SHEETS AND STAGE 1 STEEL VIO SHEETS):

1260mm for loads up to 1.5kN/M²

660mm for loads 1.5 to 2.0kN/M²

300mm for loads 2 to 4kN/M²

Where substrate is Min 18mm ply or Min 15mm OSB 3



TITLE: Vieo Vertical Wall Covering (On Ply or OSB)

DWG NO: V10_VWC_TD_System

SCALE: NTS

ISSUE DATE: Feb 2019

Drawn by: CD Checked by: MP

(To be read in conjunction with Vieo system specification documents)

**Euroclad Group Ltd,
Wentloog Corporate Park,
Wentloog Road, Cardiff CF3 2ER
Tel: +44 (0)2922 010101
Fax: +44 (0)2922 010122
Website: www.vieorooft.com**

This draft drawing has been supplied by Euro Clad Ltd for the purpose of guidance free of charge. It is a suggested typical detail and as such should not be assumed suitable for any specific project or application. No responsibility is assumed for errors or misinterpretations resulting from the information contained in the drawing. Details are for illustration only and no liability is accepted. We reserve the right to change the details without notice. The drawing is copyright, it remains our property.

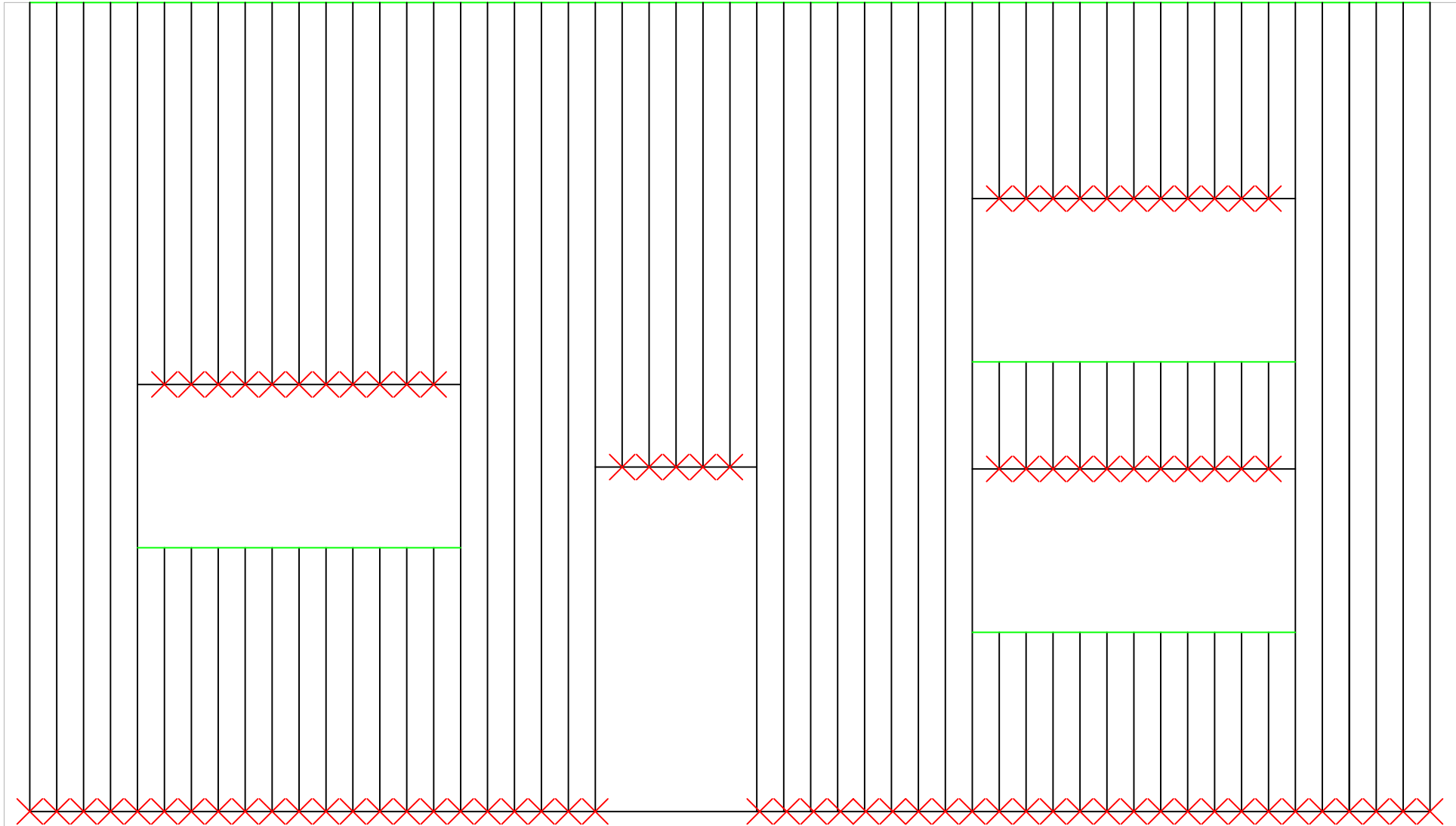

× Fixed Point — Expansion allowance under flashing



TITLE: Vieo Vertical Wall Covering (On Ply or OSB)

DWG NO: V10_VWC_TD_System

SCALE: NTS

ISSUE DATE: Feb 2019

(To be read in conjunction with Vieo system specification documents)

**Euroclad Group Ltd,
Wentloog Corporate Park,
Wentloog Road, Cardiff CF3 2ER
Tel: +44 (0)2922 010101
Fax: +44 (0)2922 010122
Website: www.vieorooft.com**

Drawn by: CD Checked by: MP

This draft drawing has been supplied by Euro Clad Ltd for the purpose of guidance free of charge. It is a suggested typical detail and as such should not be assumed suitable for any specific project or application. No responsibility is assumed for errors or misinterpretations resulting from the information contained in the drawing. Details are for illustration only and no liability is accepted. We reserve the right to change the details without notice. The drawing is copyright, it remains our property.

**Create Fixed Point Using Clip with Additional Fixing,
Typically positioned over drip angle at sheet base.**

Assembled Front View

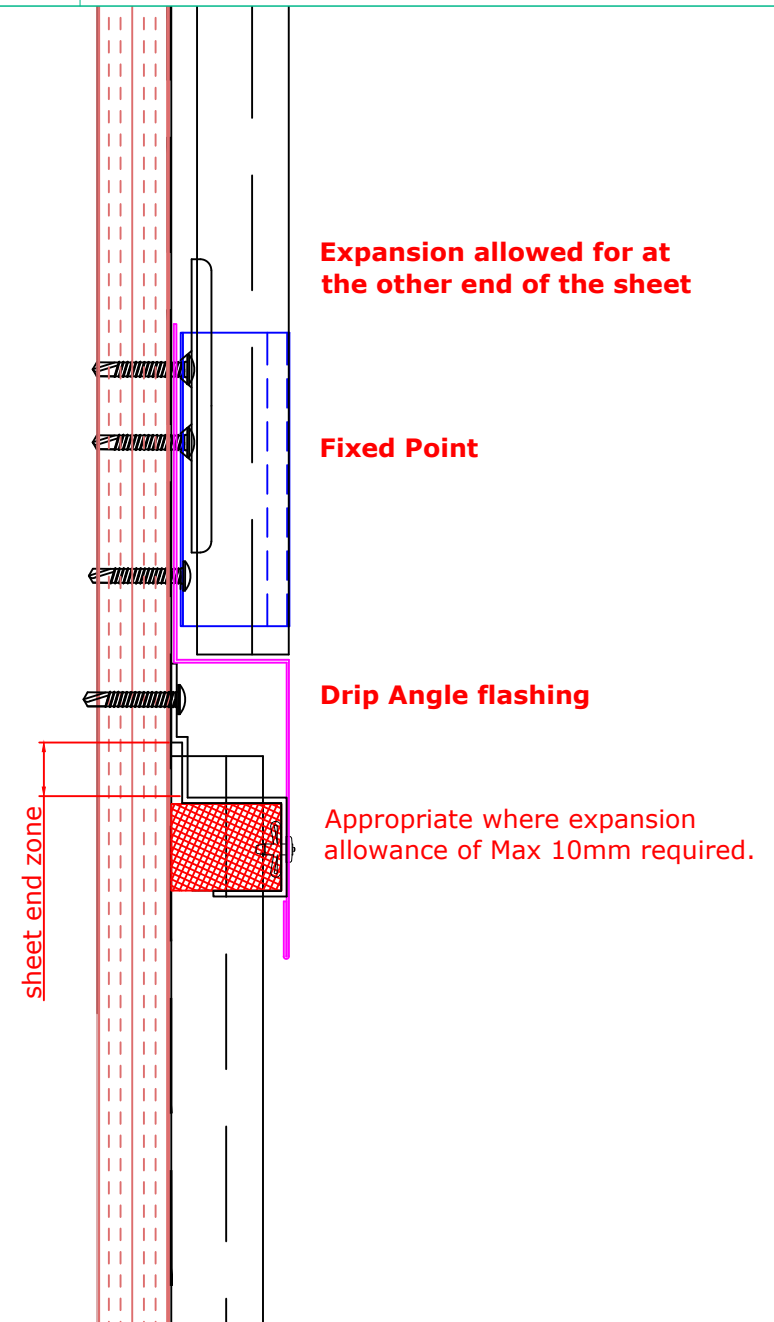
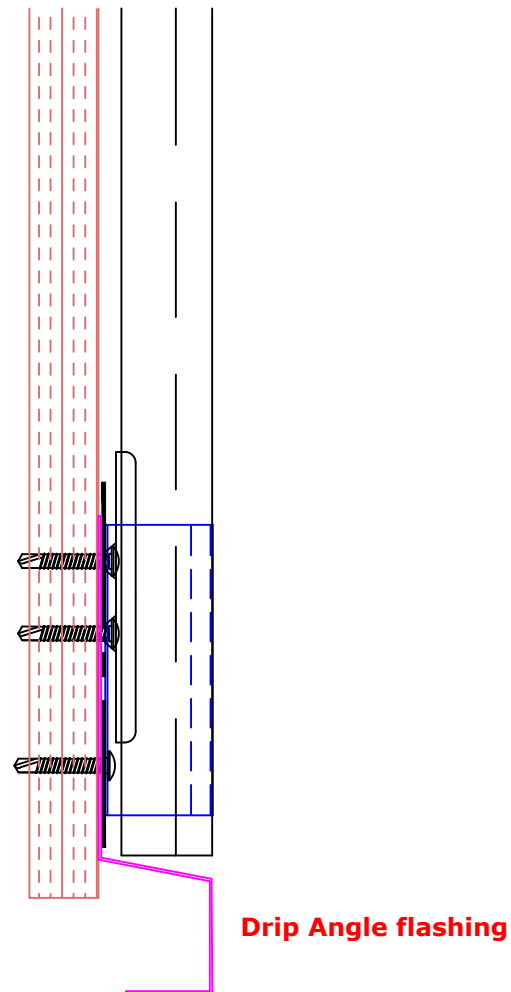
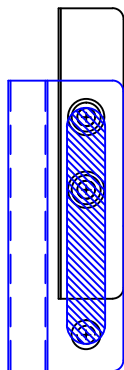

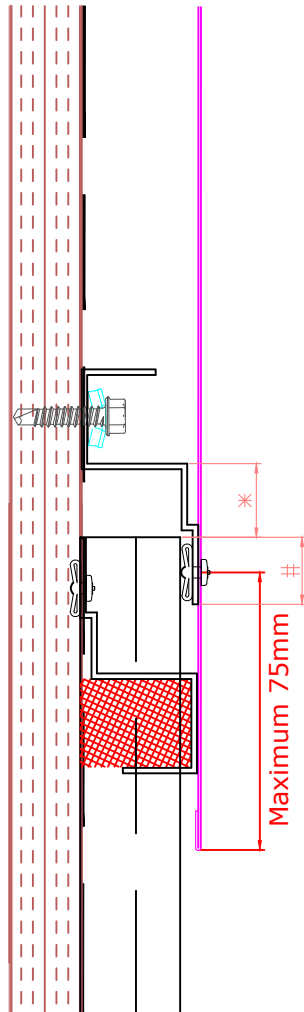

Movement typically allowed at top of sheet.

Closure with flashing fixed to decking and not through sheet.

Maximum allowable distance to next Vieo clip 300mm from closure fixing

Cover flashings fixed to structure and Vieo Closure

Flashing fixed to inverted Ridge Closure (Appropriate where expansion allowance up to 30mm is required)

*** Allow clearance for anticipated movement between support Closure, end of Vieo sheet & Ridge Closure**

end of Vieo sheet must fall under downslope edge of inverted Closure

Rivet closure to sheet prior to application

Maximum allowable to

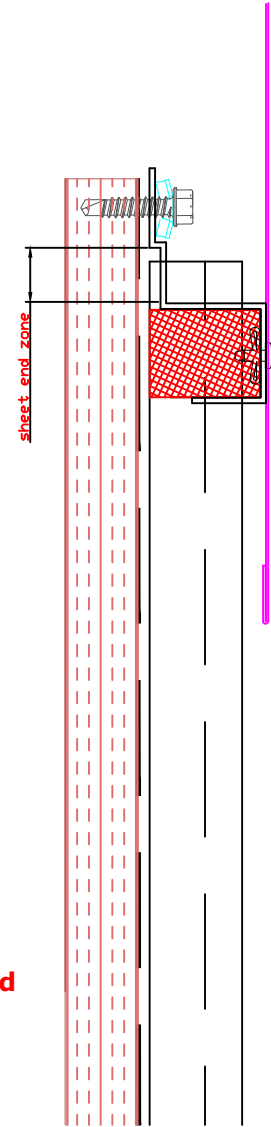

Appropriate where expansion allowance of Max 10mm required



TITLE: Vieo Vertical Wall Covering (On Ply or OSB)

DWG NO: V10_VWC_TD_System

SCALE: NTS

ISSUE DATE: Feb 2019

Drawn by: CD Checked by: MP

(To be read in conjunction with Vieo system specification documents)

**Euroclad Group Ltd,
Wentloog Corporate Park,
Wentloog Road, Cardiff CF3 2ER
Tel: +44 (0)2922 010101
Fax: +44 (0)2922 010122
Website: www.vieorooft.com**

This draft drawing has been supplied by Euro Clad Ltd for the purpose of guidance free of charge. It is a suggested typical detail and as such should not be assumed suitable for any specific project or application. No responsibility is assumed for errors or misinterpretations resulting from the information contained in the drawing. Details are for illustration only and no liability is accepted. We reserve the right to change the details without notice. The drawing is copyright, it remains our property.

Head Detail

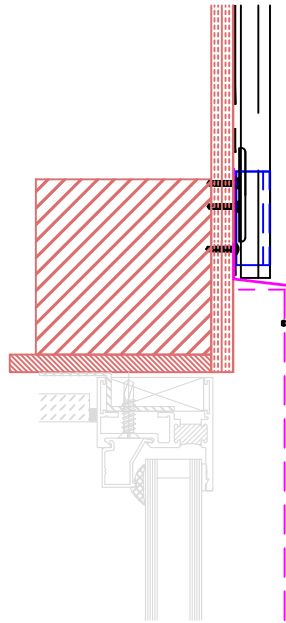

Create Fixed Point Using Clip with Additional Fixing, Typically positioned over drip angle at sheet base.

Drip Angle flashing

Cill Detail

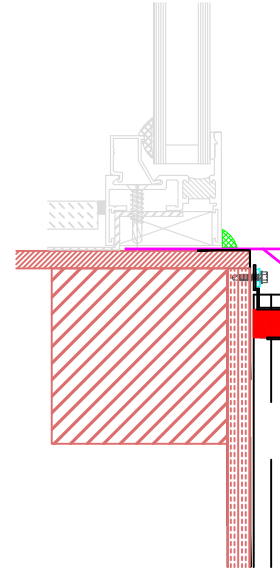

Cill flashing (with optional fall).
Edge cut on site and turned up behind Jamb flashing.
Site folded stopend also formed by cut and fold back.

Use appropriate head detail for required expansion.

Jamb Details

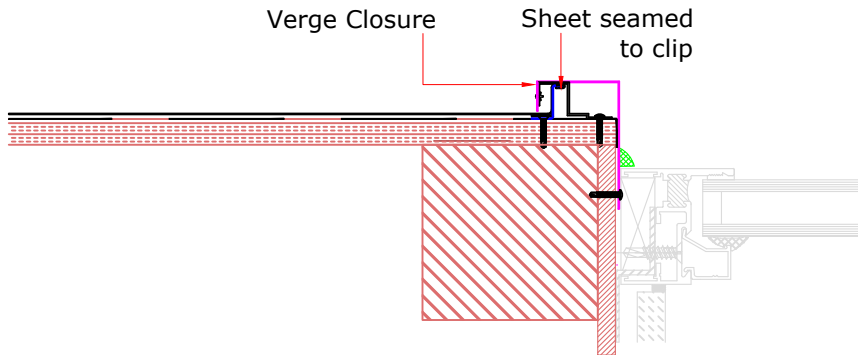

Verge Closure

Sheet seamed to clip

Sheet seamed to clip

Verge Closure

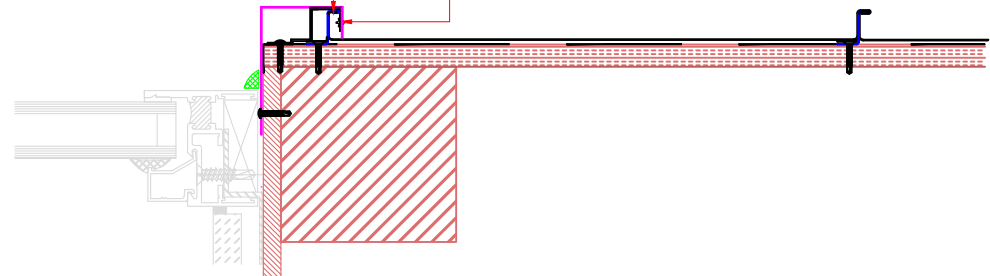



TITLE: Vieo Vertical Wall Covering (On Ply or OSB)

DWG NO: V10_VWC_TD_System

SCALE: NTS

ISSUE DATE: Feb 2019

Drawn by: CD Checked by: MP

(To be read in conjunction with Vieo system specification documents)

**Euroclad Group Ltd,
Wentloog Corporate Park,
Wentloog Road, Cardiff CF3 2ER
Tel: +44 (0)2922 010101
Fax: +44 (0)2922 010122
Website: www.vieoroof.com**

This draft drawing has been supplied by Euro Clad Ltd for the purpose of guidance free of charge. It is a suggested typical detail and as such should not be assumed suitable for any specific project or application. No responsibility is assumed for errors or misinterpretations resulting from the information contained in the drawing. Details are for illustration only and no liability is accepted. We reserve the right to change the details without notice. The drawing is copyright, it remains our property.

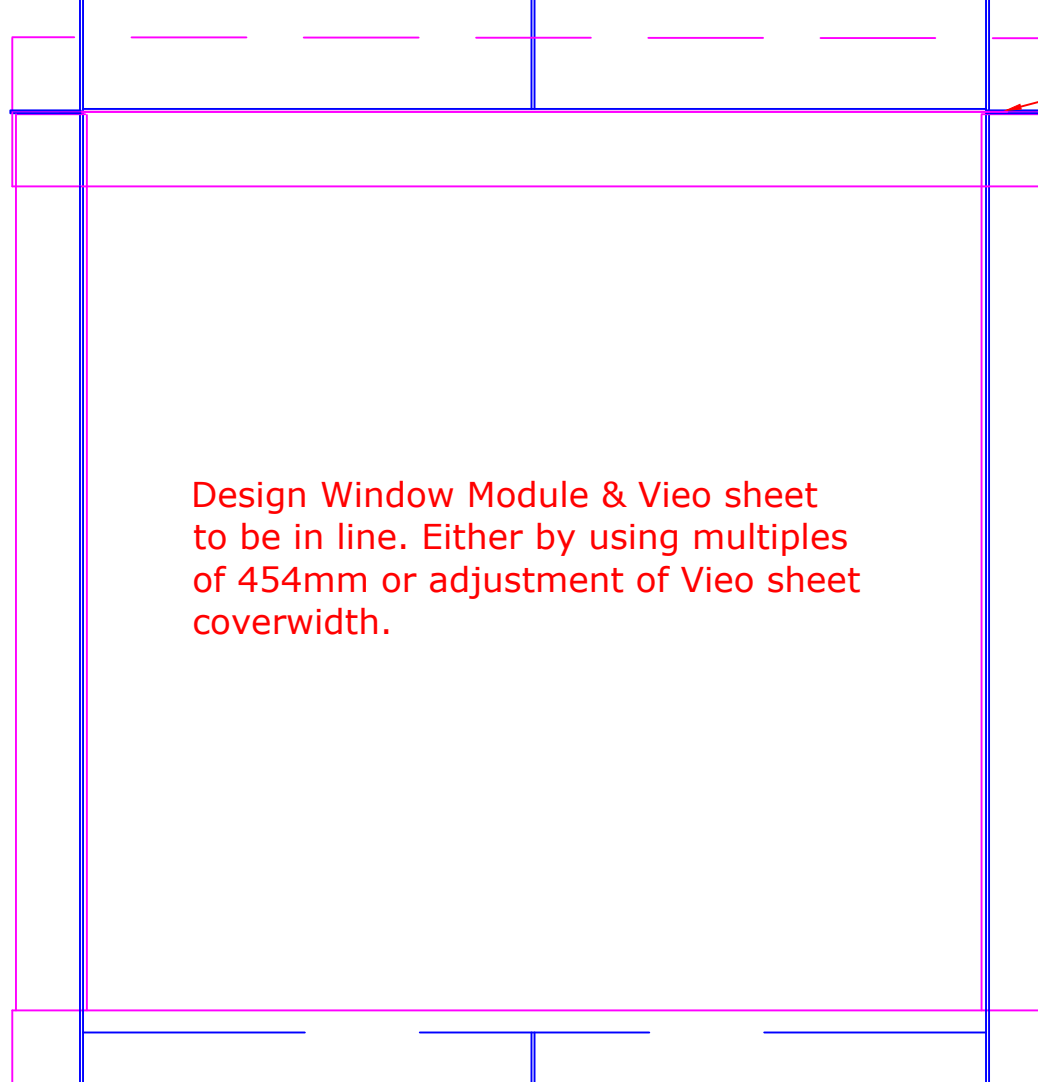

Small notch into Vieo sheet to receive drip. Sealed with mastic.

Site Folded stopend on drip

Design Window Module & Vieo sheet to be in line. Either by using multiples of 454mm or adjustment of Vieo sheet coverwidth.



TITLE: Vieo Vertical Wall Covering (On Ply or OSB)
DWG NO: V10_VWC_TD_System
SCALE: NTS
ISSUE DATE: Feb 2019

(To be read in conjunction with Vieo system specification documents)

**Euroclad Group Ltd,
Wentloog Corporate Park,
Wentloog Road, Cardiff CF3 2ER
Tel: +44 (0)2922 010101
Fax: +44 (0)2922 010122
Website: www.vieorooft.com**

This draft drawing has been supplied by Euro Clad Ltd for the purpose of guidance free of charge. It is a suggested typical detail and as such should not be assumed suitable for any specific project or application. No responsibility is assumed for errors or misinterpretations resulting from the information contained in the drawing. Details are for illustration only and no liability is accepted. We reserve the right to change the details without notice. The drawing is copyright, it remains our property.

Head Detail

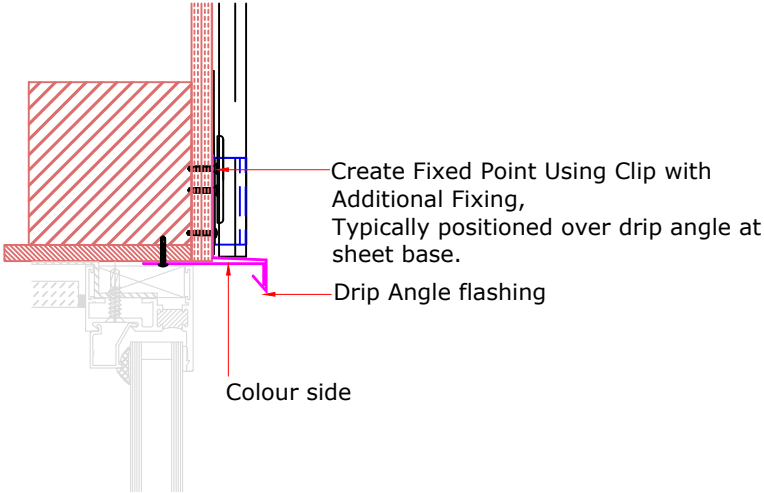

Cill Detail

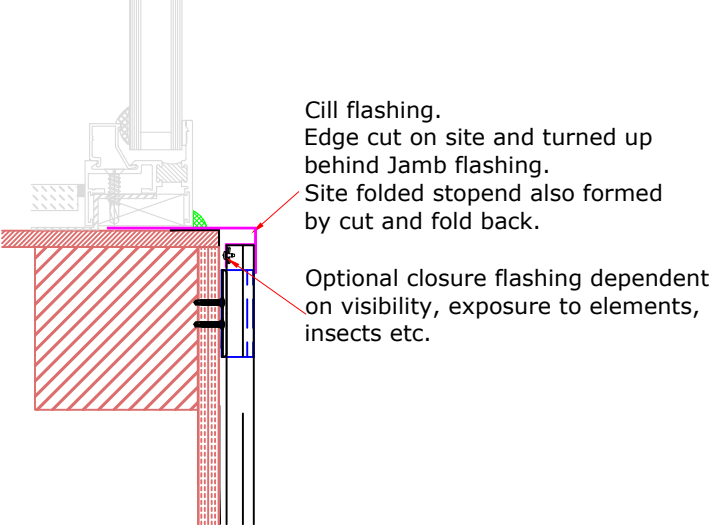

Jamb Details

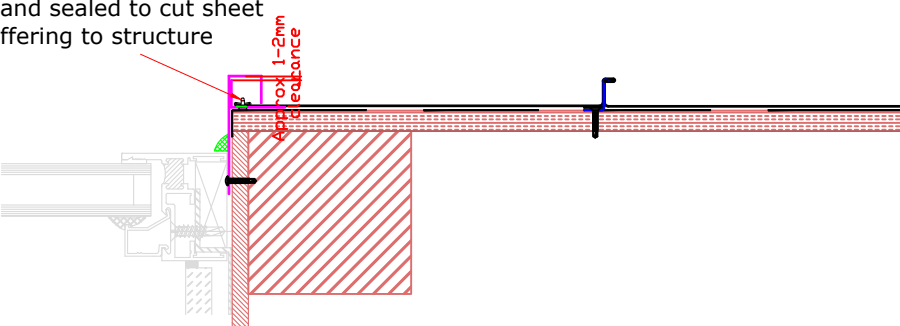
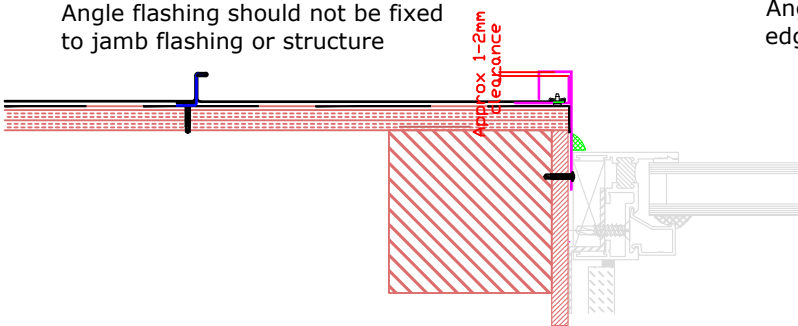



TITLE: Vieo Vertical Wall Covering (On Ply or OSB)

DWG NO: V10_VWC_TD_System

SCALE: NTS

ISSUE DATE: Feb 2019

Drawn by: CD Checked by: MP

(To be read in conjunction with Vieo system specification documents)

**Euroclad Group Ltd,
Wentloog Corporate Park,
Wentloog Road, Cardiff CF3 2ER
Tel: +44 (0)2922 010101
Fax: +44 (0)2922 010122
Website: www.vieorooft.com**

This draft drawing has been supplied by Euro Clad Ltd for the purpose of guidance free of charge. It is a suggested typical detail and as such should not be assumed suitable for any specific project or application. No responsibility is assumed for errors or misinterpretations resulting from the information contained in the drawing. Details are for illustration only and no liability is accepted. We reserve the right to change the details without notice. The drawing is copyright, it remains our property.

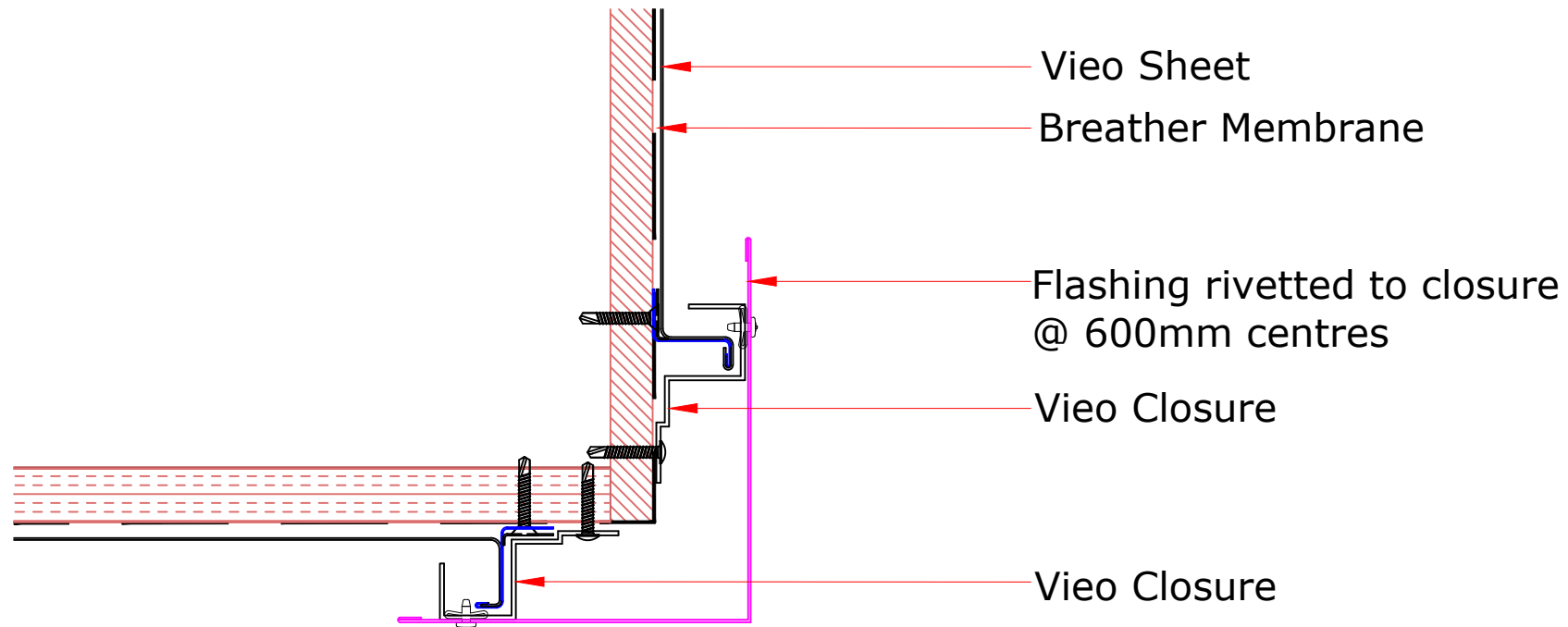



TITLE: Vieo Vertical Wall Covering (On Ply or OSB)

DWG NO: V10_VWC_TD_System

SCALE: NTS

ISSUE DATE: Feb 2019

Drawn by: CD Checked by: MP

(To be read in conjunction with Vieo system specification documents)

**Euroclad Group Ltd,
Wentloog Corporate Park,
Wentloog Road, Cardiff CF3 2ER
Tel: +44 (0)2922 010101
Fax: +44 (0)2922 010122
Website: www.vieorooft.com**

This draft drawing has been supplied by Euro Clad Ltd for the purpose of guidance free of charge. It is a suggested typical detail and as such should not be assumed suitable for any specific project or application. No responsibility is assumed for errors or misinterpretations resulting from the information contained in the drawing. Details are for illustration only and no liability is accepted. We reserve the right to change the details without notice. The drawing is copyright, it remains our property.

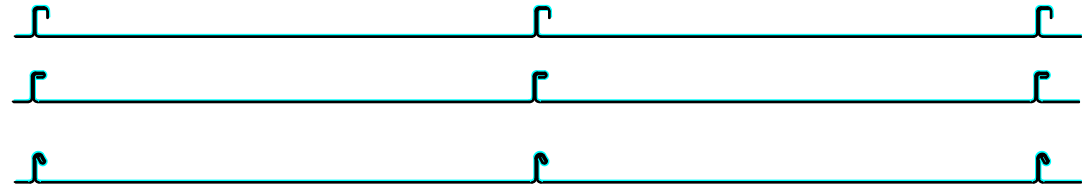

SEAMING OPTIONS AT END LAP

For advice on fixed point locations please contact Euroclad Technical

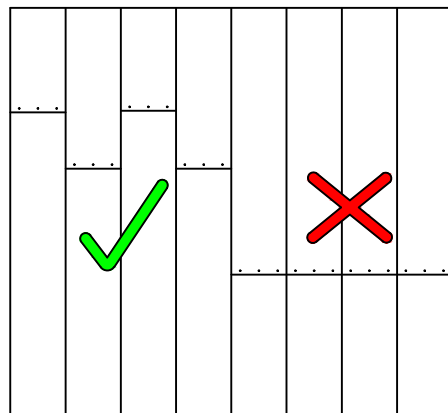
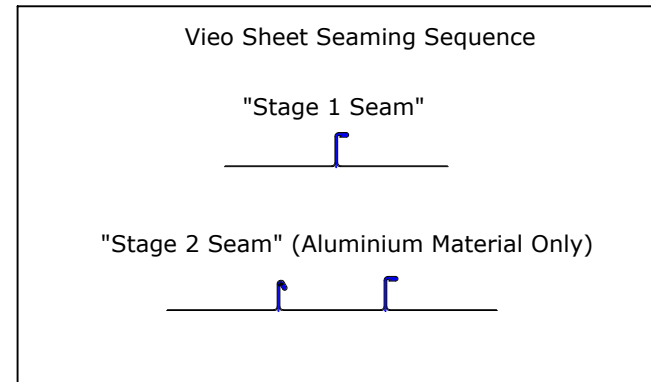
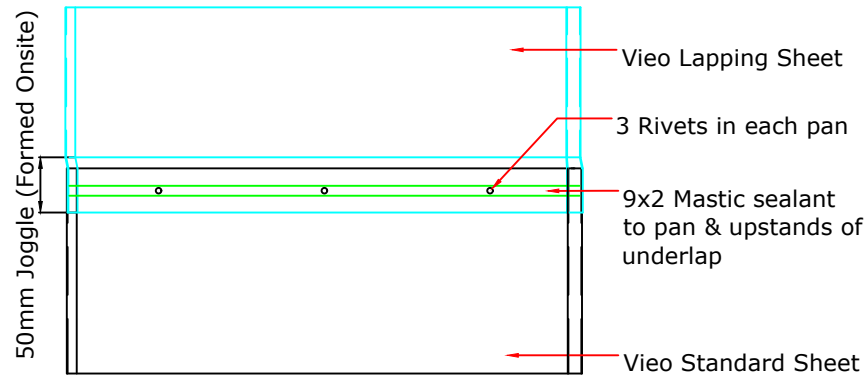

Lap joints must be staggered at least 100mm apart
Clips minimum 100mm from joint

Vieo Sheets cut on site prior to jointing

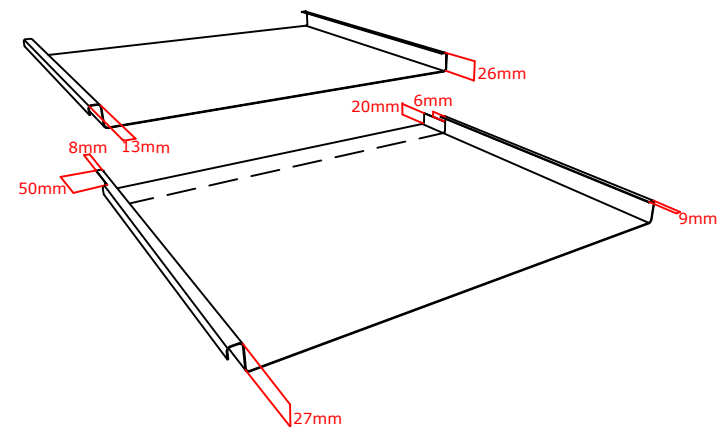

STEP 1

Damaged sheets in red



STEP 2

Cut off upstands of damaged sheets

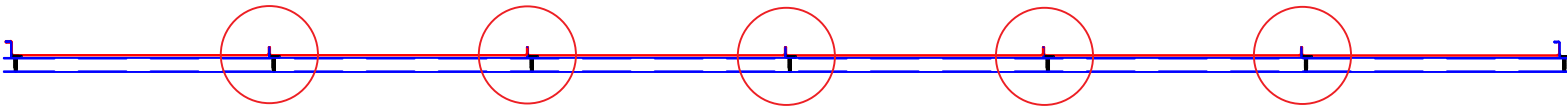

STEP 3

Remove the central damaged sheets and clips

Lift up cut sheet edge to remove clip

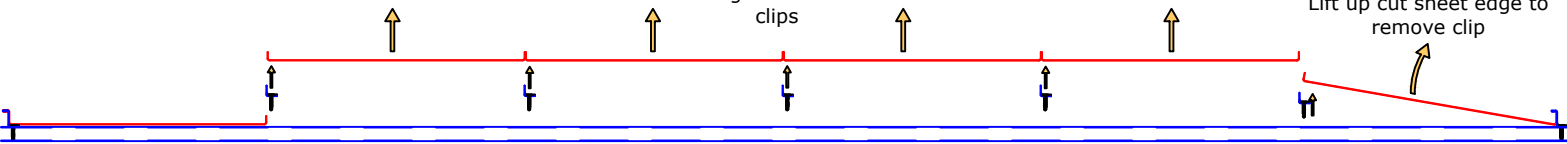

STEP 4

Apply touch up paint to cut edge.

Apply an adhesive to bond the single upstand sheet to the damaged sheet.

Lay down new sheets and clips.
Note: Clip Fixings to be offset from existing fixing holes

Apply an adhesive to bond the single upstand sheet to the damaged sheet.

Apply touch up paint to cut edge.

Damaged sheet cut back from cut off upstand to provide a flat bonding surface.

Damaged sheet cut back from cut off upstand to provide a flat bonding surface.

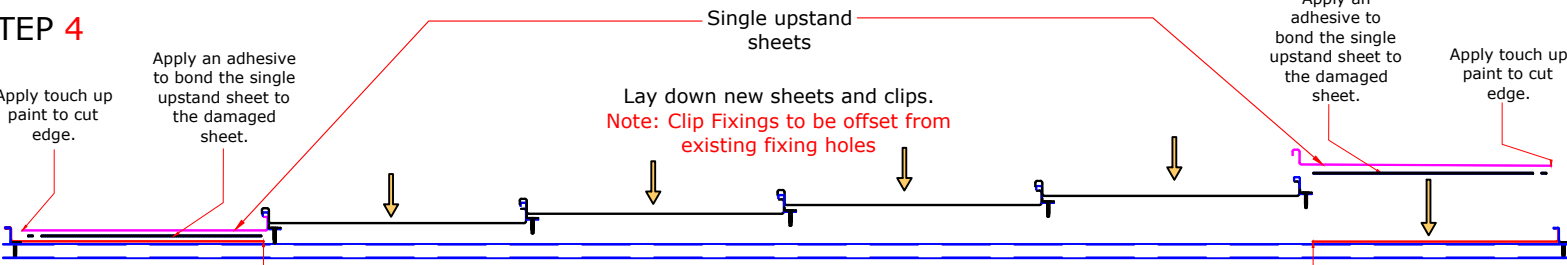

STEP 5

New sheets in place

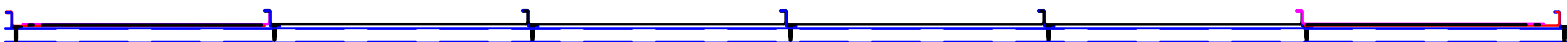

Single upstand sheet should be manufactured narrower than what was originally ordered to allow for creep of new sheets.

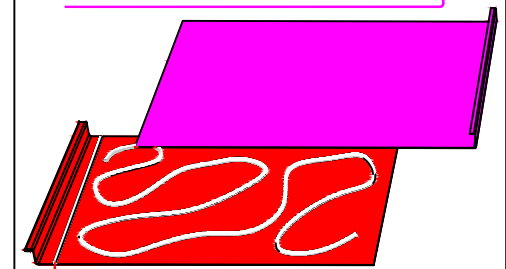

Continuous run of adhesive set back by 10-15mm from sheet edge to be of consistent bead size.

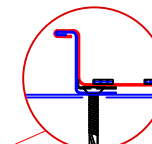

Pressure should be applied to achieve a bond and seal along sheet length. Use sealed rivets if necessary.