

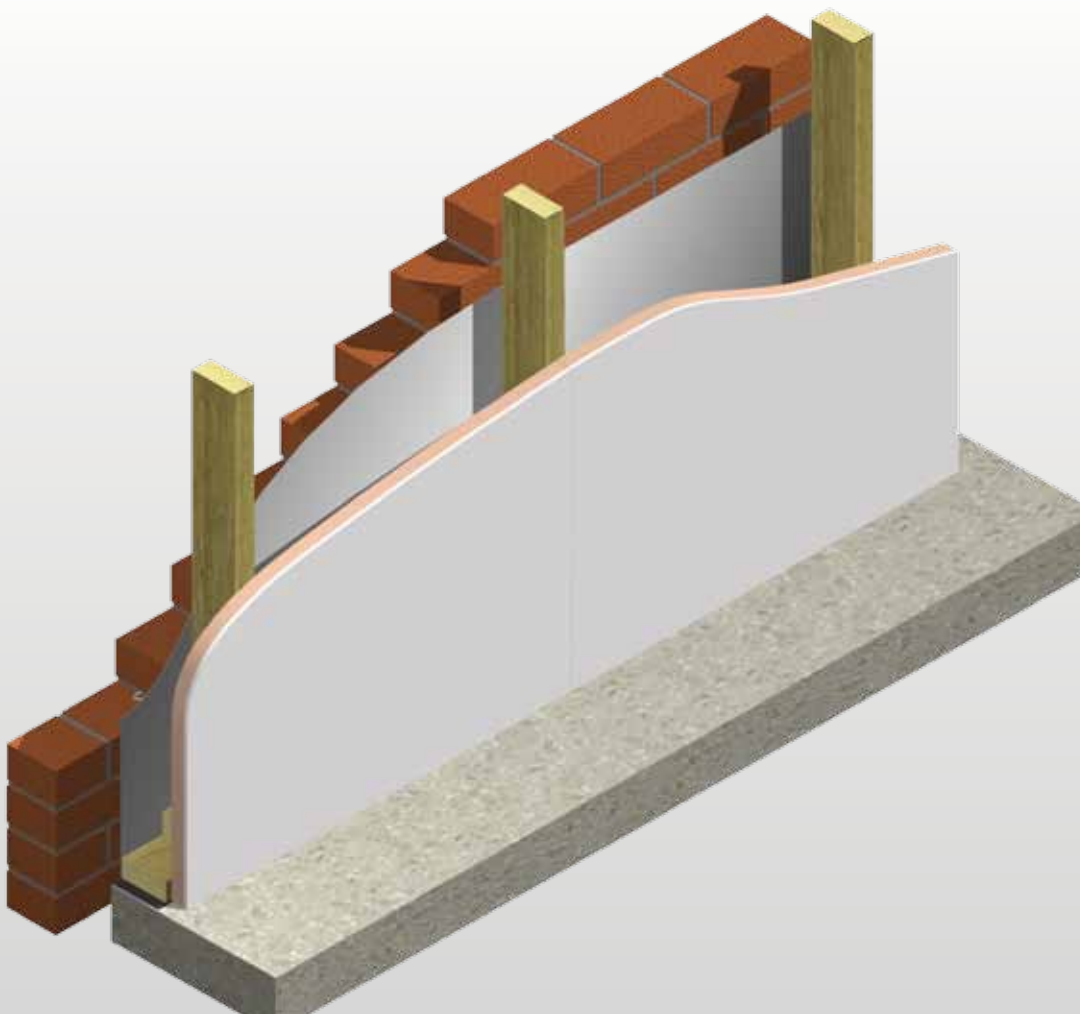

# Kooltherm™ K18 Insulated Plasterboard

INSULATED DRY-LINING PLASTERBOARD FOR MECHANICAL FIXING



- Super high performance rigid thermoset phenolic insulation
- Fibre-free, closed cell insulation core
- 3-in-1 insulation, dry-lining and vapour control
- Group 1 BCA fire classification
- Allows quick response heating and cooling
- Clear cavity is maintained - resists moisture penetration
- Resistant to the passage of water vapour
- Easy to handle and install
- Ideal for new build and refurbishment
- Manufactured with a CFC/HCFC-free blowing agent that has zero ODP and low GWP
- Compliant with AS/NZS 4859.1
- ISO 9001 Quality Standards\*



Low Energy –  
Low Carbon Buildings

# Typical Constructions and Total R-values

## Mechanically Fixed to Timber Framing

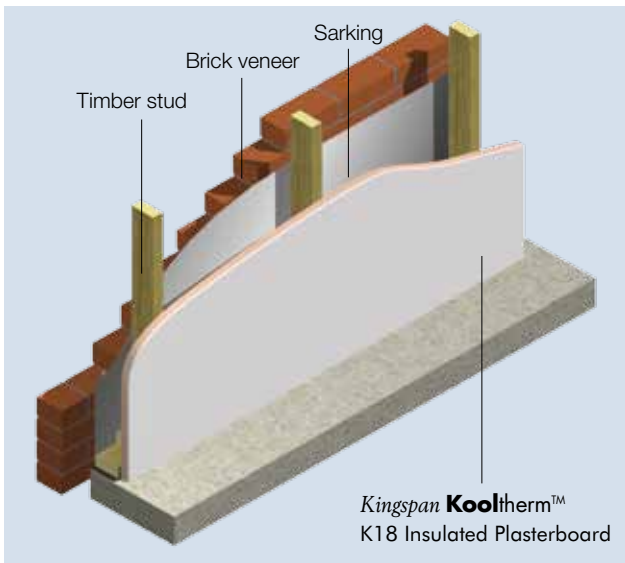

Figure 1

Total R-values for various product thicknesses of Kingspan Kooltherm™ K18 Insulated Plasterboard		
Product Thickness (inc. Plasterboard)	Heat flow in	Heat flow out
35 mm	R <sub>T</sub> 2.2	R <sub>T</sub> 2.3
40 mm	R <sub>T</sub> 2.5	R <sub>T</sub> 2.6
50 mm	R <sub>T</sub> 3.1	R <sub>T</sub> 3.1
60 mm	R <sub>T</sub> 3.6	R <sub>T</sub> 3.6
70 mm	R <sub>T</sub> 4.1	R <sub>T</sub> 4.2
80 mm	R <sub>T</sub> 4.6	R <sub>T</sub> 4.7
90 mm	R <sub>T</sub> 5.1	R <sub>T</sub> 5.2

## Mechanically Fixed to Internal Side of Steel Frame

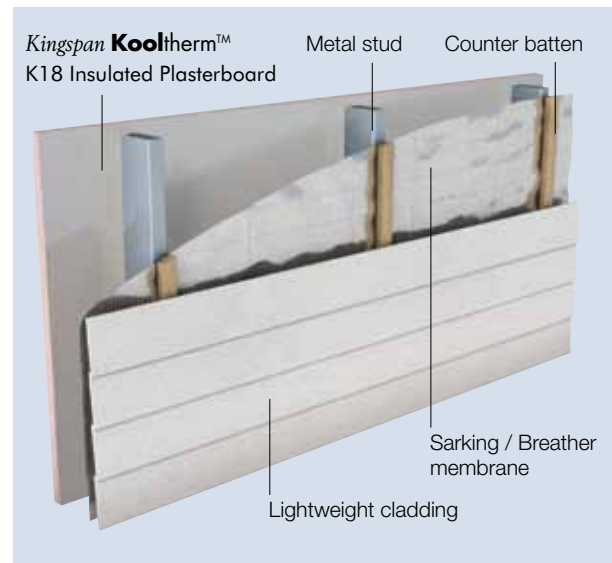

Figure 2

Total R-values for various product thicknesses of Kingspan Kooltherm™ K18 Insulated Plasterboard		
Product Thickness (inc. Plasterboard)	Heat flow in	Heat flow out
35 mm	R <sub>T</sub> 2.1	R <sub>T</sub> 2.2
40 mm	R <sub>T</sub> 2.4	R <sub>T</sub> 2.5
50 mm	R <sub>T</sub> 2.9	R <sub>T</sub> 2.9
60 mm	R <sub>T</sub> 3.5	R <sub>T</sub> 3.5
70 mm	R <sub>T</sub> 4.0	R <sub>T</sub> 4.0
80 mm	R <sub>T</sub> 4.5	R <sub>T</sub> 4.6
90 mm	R <sub>T</sub> 5.0	R <sub>T</sub> 5.1

### Assumptions

The R-values shown are Total R-values for the building element as required by the Energy Provisions of the Building Code of Australia. Kingspan Kooltherm™ products are manufactured, tested and packaged in conformance with AS/NZS 4859.1.

The contribution of the product Total R-values depends on installation and environmental conditions. The R-value will be reduced in the event of the accumulation of dust on the upward facing surfaces and in those cavities that are ventilated.

### Mechanically Fixed to Internal Side of Timber Frame

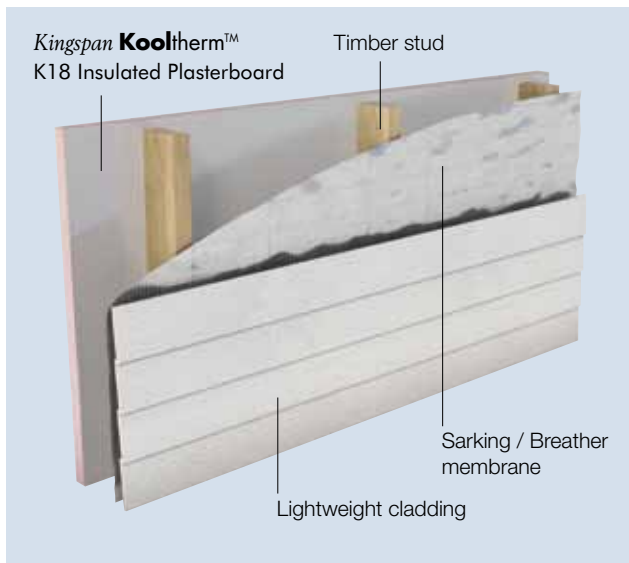

Figure 3

Total R-values for various product thicknesses of Kingspan Kooltherm™ K18 Insulated Plasterboard		
Product Thickness (inc. Plasterboard)	Heat flow in	Heat flow out
35 mm	R <sub>f</sub> 2.1	R <sub>f</sub> 2.2
40 mm	R <sub>f</sub> 2.4	R <sub>f</sub> 2.5
50 mm	R <sub>f</sub> 2.9	R <sub>f</sub> 2.9
60 mm	R <sub>f</sub> 3.5	R <sub>f</sub> 3.5
70 mm	R <sub>f</sub> 4.0	R <sub>f</sub> 4.0
80 mm	R <sub>f</sub> 4.5	R <sub>f</sub> 4.6
90 mm	R <sub>f</sub> 5.0	R <sub>f</sub> 5.1

### Mechanically Fixed to Timber Rafters (Covered Beams)

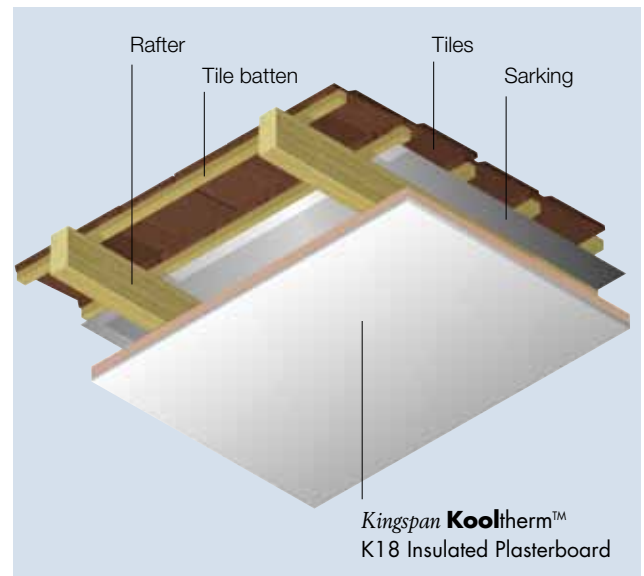

Figure 4

Total R-values for various product thicknesses of Kingspan Kooltherm™ K18 Insulated Plasterboard		
Product Thickness (inc. Plasterboard)	Heat flow in	Heat flow out
35 mm	R <sub>f</sub> 2.3	R <sub>f</sub> 2.0
40 mm	R <sub>f</sub> 2.5	R <sub>f</sub> 2.2
50 mm	R <sub>f</sub> 3.0	R <sub>f</sub> 2.7
60 mm	R <sub>f</sub> 3.6	R <sub>f</sub> 3.3
70 mm	R <sub>f</sub> 4.1	R <sub>f</sub> 3.8
80 mm	R <sub>f</sub> 4.6	R <sub>f</sub> 4.3
90 mm	R <sub>f</sub> 5.1	R <sub>f</sub> 4.8

# Product Details

## Product Description

**Kingspan Kooltherm™ K18 Insulated Plasterboard** is a super high performance, fibre-free rigid thermoset closed cell phenolic insulation core, sandwiched between a front facing of tapered edge gypsum based plasterboard, and a reverse facing of low emissivity foil autohesively bonded to the insulation core during manufacture.



**Kingspan Kooltherm™ K18 Insulated Plasterboard** is manufactured without the use of CFCs/HCFCs and has zero Ozone Depletion Potential (ODP) and low Global Warming Potential (GWP).



Product Data		
Thermal Conductivity ( $\lambda$ -value)	Insulant	0.020 W/m-K (Insulant Thickness $\geq$ 45 mm) 0.021 W/m-K (Insulant Thickness 25 - 44 mm)
	Plasterboard	0.17 W/m-K (Plasterboard Thickness 10 mm)
Emittance	Foil Face	E0.14
Product Dimensions		2400 mm x 1200 mm (2.88 m <sup>2</sup> )
Product Thickness (inc. Plasterboard)		35, 40, 50, 60, 70, 80, 90 mm
Plasterboard Thickness		10 mm

## Product R-value

Product Thickness (inc. Plasterboard)	Product R-value
35 mm	R1.3
40 mm	R1.5
50 mm	R2.0
60 mm	R2.6
70 mm	R3.1
80 mm	R3.6
90 mm	R4.1

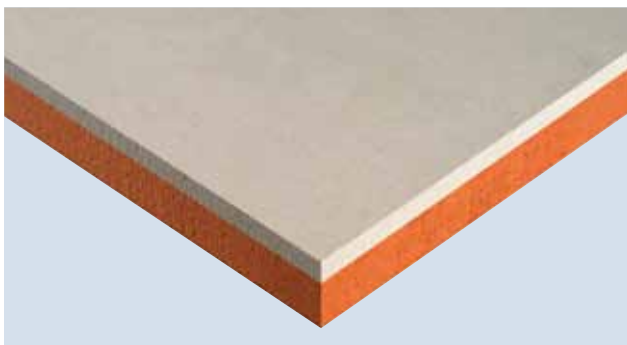

Figure 5 Super high performance **Kingspan Kooltherm™ K18 Insulated Plasterboard**

## Specification Guide

### **Kingspan Kooltherm™ K18 Insulated Plasterboard**

The wall dry-lining insulation shall be **Kingspan Kooltherm™ K18 Insulated Plasterboard** \_\_\_\_\_ mm thick, comprising a CFC/HCFC-free and zero Ozone Depletion Potential (ODP) rigid thermoset phenolic insulation core with 10 mm plasterboard facing bonded to its front surface and a composite foil facing on its reverse surface, manufactured\* under a management system certified to BS / I.S. EN ISO 9001:2008, BS / I.S. EN ISO 14001:2004 and BS / I.S. OHSAS 18001:2007 by Kingspan Insulation Limited and shall be installed in accordance with the instructions issued by them.

\* Applies only to the **Kingspan Kooltherm™ K10** insulation board used in the manufacture of this composite insulated plasterboard product.

## Standards and Approvals

**Kingspan Kooltherm™ K10** insulation board used for **Kingspan Kooltherm™ K18 Insulated Plasterboard** is manufactured to the highest standards and certified under the following management systems:

Standard	Management System
BS / I.S. EN ISO 9001:2008	Quality Management
BS / I.S. EN ISO 14001:2004	Environmental Management
BS / I.S. OHSAS 18001:2007	Health and Safety Management

## Product Testing

Characteristic	Standard	Result
Compressive Strength	BS / I.S. EN 826:1996	Typically exceeds 100 kPa at 10% compression
Water Vapour Resistivity	BS EN 12086:1997 / I.S. EN 12086:1998	> 100 MN-s/g-m  For the purpose of calculation of condensation risk, the resistivity of the plasterboard component of the product should be taken as 50 MN-s/g-m.

## Fire Performance

Test	Test Method	Result
Ignitability, Flame spread Heat release, Smoke release	AS 1530.3	0/0/0/0-1*
Group Classification	AS/NZS 3837	Group 1**
Fire Propagation Surface Spread of Flame	BS 476 Part 6 BS 476 Part 7	Class 0***

\* Applies only to the **Kingspan Kooltherm™ K10** insulation board used in the manufacture of this composite insulated plasterboard product.

\*\* Applies to compliant plasterboard facing.

\*\*\* Applies only to the **Kingspan Kooltherm™** insulation core.

## Durability

If correctly applied, **Kingspan Kooltherm™** products can be expected to have a long life of service.

Their durability depends on the supporting structure and the conditions of its use.

**Kingspan Kooltherm™** products are warranted for a period of 10 years for both residential and commercial installations.\*

*\* Subject to the terms of the complete **Kingspan Kooltherm™** warranty document which is available upon request or downloadable from [www.kingspaninsulation.asia](http://www.kingspaninsulation.asia)*

## Limitations

**Kingspan Kooltherm™** K18 Insulated Plasterboard has a gypsum plasterboard face. It should, therefore, not be used to isolate dampness nor be used in continuously damp or humid conditions.

## Environmental Data

Aspect	Characteristic
Recyclability	Non-contaminated insulation site waste is recyclable, but there are currently no facilities in Australia to process returned material
Re-usability	Re-usable if removed with care (long term of service expected)
Water Use	No water used in Kingspan Insulation's manufacturing process
Blowing Agent Global Warming Potential (GWP)	Manufactured with a blowing agent that has low GWP
Blowing Agent Ozone Depletion Potential (ODP)	Manufactured with a CFC/HCFC-free blowing agent that has zero ODP
Packaging	Contains 0% recycled product Polythene wrap and EPS skids 100% recyclable

# Installation Instructions

## Dry Wall Plasterboard

*Kingspan Kooltherm™ K18 Insulated Plasterboard* can be applied utilising a variety of traditional or modern dry-lining techniques, to dry and structurally sound walls. These include traditional mechanical fixing to either metal furring systems or vertical timber battens systems. The particular system employed will depend on the construction or design of the wall to which *Kingspan Kooltherm™ K18 Insulated Plasterboard* is to be fixed. The tapered edge to the plasterboard enables a flat seamless surface equal to traditional plaster finishes after the correct jointing procedures as per plasterboard manufacturer's recommendation have been completed.

*Kingspan Kooltherm™ K18 Insulated Plasterboard* must be installed in accordance with AS/NZS 2589:2007 Gypsum linings – Application and finishing.

## Mechanical Fixing to Vertical Timber / Battens / Metal Stud and Track

This method may be used on timber frame, metal stud and track constructions or on any dry masonry wall that will support and retain the battens and associated fixings.

1. Place framing / battens at a maximum of 600 mm centres and positioned horizontally at floor and ceiling level / horizontal joints to support the *Kingspan Kooltherm™ K18 Insulated Plasterboard*.
2. Ensure the framing/ battens will be wide enough to offer a minimum 20 mm support to all edges of the board.
3. Use plasterboard screws long enough to allow for a minimum 20 mm embedment into the stud or, alternatively, suitable galvanised plasterboard nails, should be placed at 200 mm centres and not less than 10 mm from the edges of the board along the line of the studs.
4. Drive fixings straight and embed heads just below the surface of the board. Care should be taken not to overdrive the fixing.
5. Screws used for plasterboard fixing must comply with AS 3566.2:2002 self-drilling screws complying with the building and construction industry corrosion resistance requirements.

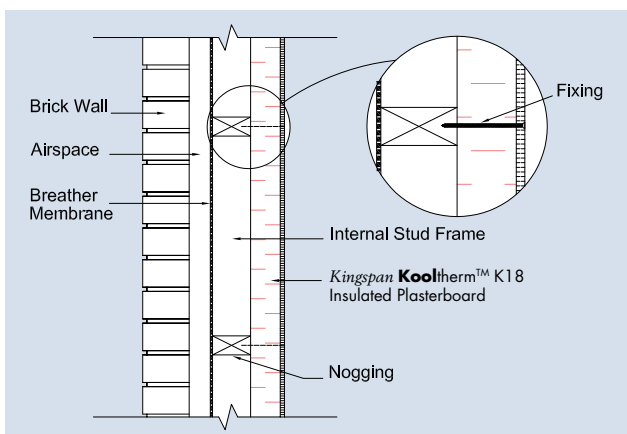

Figure 6 Side elevation - Brick veneer wall with *Kingspan Kooltherm™ K18 Insulated Plasterboard*

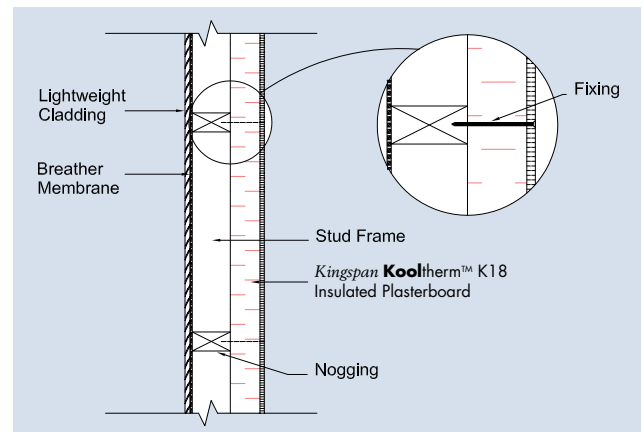

Figure 7 Side elevation - Lightweight clad stud wall with *Kingspan Kooltherm™ K18 Insulated Plasterboard*

## Mechanical Fixing to Metal Furring Systems

*Kingspan Kooltherm™ K18 Insulated Plasterboard* can be fixed by the use of proprietary metal support systems to brick, block, stone or concrete walls. The metal frame should be fixed to the masonry or concrete walls.

1. Provide a true and level base for the *Kingspan Kooltherm™ K18 Insulated Plasterboard* by fixing the metal frame to the masonry or concrete wall in accordance with the manufacturer's instructions.
2. Set the frame vertically at a maximum of 600 mm centres to coincide with the board joints and the midpoint of the board.
3. Fix the *Kingspan Kooltherm™ K18 Insulated Plasterboard* to each metal framing section with self drilling plasterboard screws at 200 mm centres.
4. Drive fixings straight and embed heads just below the surface of the board. Care should be taken not to overdrive the fixing.

## Mechanical Fixing to Timber Joists or Rafters

*Kingspan Kooltherm™ K18 Insulated Plasterboard* may be used to line ceilings or infill where an exposed rafter is desired. Installation is similar to that of standard plasterboard.

1. A minimum of 20 mm bearing onto the timbers must be offered at each sheet joint.
2. Sheets should be fixed using either drywall screws or suitable galvanised plasterboard nails located at 150 mm centres.
3. Ensure fixings are located no less than 10 mm from the edges of the sheet.
4. Fixings should be long enough to allow a minimum embedment of 20 mm into the timber.
5. Fixings should be driven straight with the heads embedded just below the surface of the sheet. Care should be taken not to overdrive the fixing.

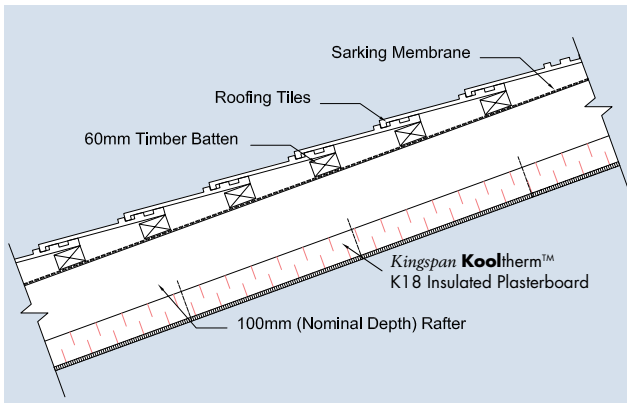

Figure 8 Side elevation - Raked ceiling with Kingspan Kooltherm™ K18 Insulated Plasterboard

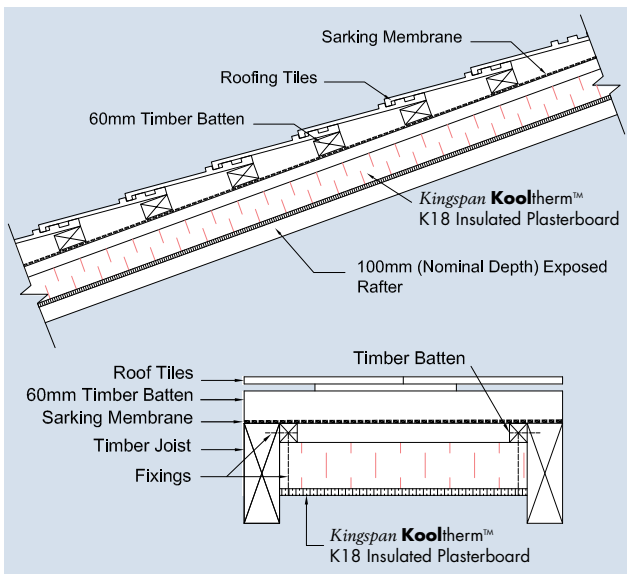

Figure 9 Side and front elevation - Raked ceiling (exposed beam) with Kingspan Kooltherm™ K18 Insulated Plasterboard

## General Requirements

### Cutting

Cutting should be carried out either by using a fine toothed saw, or by scoring with a sharp knife through the insulation and scoring the back of the plasterboard itself, then snapping the board over a straight edge and then cutting the facing on the other side. Ensure accurate trimming to achieve close-butting joints and continuity of insulation.

### Packaging

According to quantity, the boards are supplied in packs, labelled and shrink-wrapped in polythene.

## Handling and Storage

### Storage

The packaging of Kingspan Kooltherm™ should not be considered adequate for long term outdoor protection. Ideally boards should be stored inside a building. If, however, outdoor storage cannot be avoided then the boards should be stacked clear of the ground and covered with an opaque polythene sheet or weatherproof tarpaulin. Boards that have been allowed to get wet should not be used.

### Resistance to Solvents

The insulation core is resistant to short-term contact with petrol and with most dilute acids, alkalis and mineral oils. However, it is recommended that any spills be cleaned off fully before the boards are installed. Ensure that safe methods of cleaning are used, as recommended by suppliers of the spilt liquid. The insulation core is not resistant to some solvent-based adhesive systems, particularly those containing methyl ethyl ketone. Adhesives containing such solvents should not be used in association with this product. Damaged boards or boards that have been in contact with harsh solvents or acids should not be used.

### OH & S

Kingspan Insulation products are chemically inert and safe to use. A Product Safety Information sheet is available from Kingspan Insulation Pty Ltd.

Please note that the reflective surfaces on this product are designed to enhance their thermal performance. As such, they will reflect light as well as heat, including ultraviolet light. Therefore, if these boards are being installed during bright or sunny weather, it is advisable to wear UV protective sunglasses or goggles and if the skin is exposed for a significant period of time, to protect bare skin with a UV block sun cream.

**Foil facings are conductive to electricity - avoid contact with un-insulated electrical cables and fittings.**

# Contact Details

## General Enquiries

Email: [info@kingspaninsulation.asia](mailto:info@kingspaninsulation.asia)

*Kingspan Insulation Pty. Ltd. reserves the right to amend product specifications without prior notice. The information, technical details and fixing instructions etc. included in this literature are given in good faith and apply to uses described. Recommendations for use should be verified as to the suitability and compliance with actual requirements, specifications and any applicable laws and regulations. For other applications or conditions of use, Kingspan Insulation offers a Technical Advisory Service the advice of which should be sought for uses of Kingspan Insulation products that are not specifically described herein. Please check that your copy of the literature is current by contacting us or visiting [www.kingspaninsulation.asia](http://www.kingspaninsulation.asia)*



**Kingspan Insulation Pty Ltd**

Email: [info@kingspaninsulation.asia](mailto:info@kingspaninsulation.asia)

[www.kingspaninsulation.asia](http://www.kingspaninsulation.asia)

\* Applies only to the Kingspan **Kooltherm**™ K10 insulation board used in the manufacture of this composite insulated plasterboard product

™ Kingspan, Kooltherm, the zo Device and the Lion Device are Registered Trademarks of the Kingspan Group plc in Australia and other countries. All rights reserved.

© Kingspan Insulation Pty Ltd